

VEIKONG

VFD530 High Performance PMSM AC Drives FREQUENCY INVERTER



VEIKONG

— We can do it more! —

ShenZhen VEIKONG Electric CO.,Ltd.

Factory address: 4F, Building 5, Dongluyang Industrial, Park, No.4 Tengfeng 4th Road,

Fuyong Phoenix Third, Industrial Zone, Baoan District, Shenzhen, China

Phone number: +8675589587650

Website: www.veikong-electric.com

www.veikong.com

ShenZhen VEIKONG Electric CO., Ltd.

VEIKONG INDUSTRIAL CO.,LIMITED (HK)

COMPANY PROFILE

CERTIFICATES AND QUALIFICATIONS



Professional R&D team

Brief introduction

Shenzhen VEIKONG ELECTRIC CO., LTD is a reputable high-tech enterprise that specializes in researching, manufacturing, and trading both medium and low voltage inverters and solar pumping inverter. We offer our clients integrated system solutions, and our professional R&D team and devoted management with over 20 years of experience have made us one of the first independent AC drives companies in China.

We incorporate latest high efficiency mppt calculations and SPWM, sensorless vector control, and vector and torque control technology into our VFD and solar pump inverter which have reached international advanced standards, making them able to directly replace and be equivalent to Europe, the United States, Japan, and other brands, providing our clients with the highest level of technical support.

Quality is the foundation of our enterprise, and we consistently follow ISO9001 standards to manage and supervise quality. Our products have passed CE and IEC certifications and other technical approvals, and we continuously upgrade our technologies and products to better meet our customers' requirements and market needs.

VEIKONG team believes that the customer is the source of our enterprise. We take great pride in placing our customers' requirements first and ensuring that we meet and exceed their expectations. Our products have been widely used in various industries, including solar pumping, petroleum, chemical, melting, hoisting, electric power, building materials, water supply, plastics, textiles, printing, packing, and more, to create value for our customers.

VEIKONG, your trusted supplier!

20+

Over 20 years of professional management experience



VEIKONG



VEIKONG

www.veikong-electric.com
www.veikong.com

Product Features



VFD530 High Performance PMSM AC Drives

VFD530 High Performance PMSM AC Drives

PRODUCT FEATURES

High speed stabilization accuracy, wide speed range

- . Stable speed accuracy: $\pm 0.5\%$ (V/f), $\pm 0.2\%$ (SVC) ;
- . Speed adjustment range: 1:200 (SVC)、1:1000 (VC) ;
- . Heavy duty overload capacity : Running stably with 110% rated current in long time ;
- . 150% rated current 60S ;
- . 180% rated current 10S

100hz step response

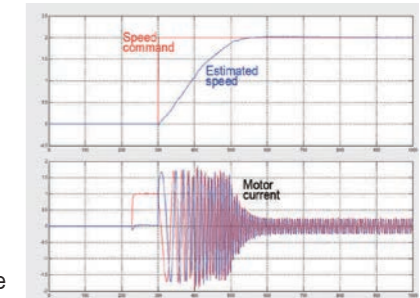

Big torque in low frequency ,fast response for output torque

- load capacity in low frequency: VF: 180% @ 0.50HZ ;
- SVC: 180% @ 0.25HZ

150% load added in 0.25hz

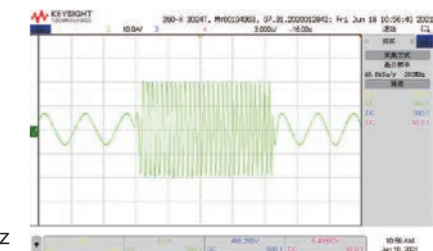

Fast dynamic response

In SVC mode, the acceleration and deceleration time can be set arbitrarily (even 0.0s) The inverter runs stably without alarming, esp in some occasions requiring quick response

0.0s acceleration and deceleration time fast forward and reverse

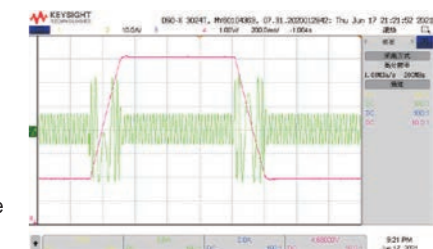

Product Features

Deceleration over excitation function

The over-excitation function is set to convert the mechanical energy of the motor when it is decelerated into motor heat to be consumed, which can shorten the deceleration time and save accessories such as braking resistors in the occasions where braking is infrequent.

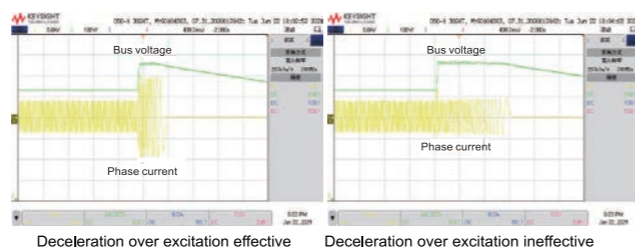

Energy-saving operation of fans and pumps

With excellent automatic energy-saving function, only need to set the maximum energy-saving target. When the operation meets the energy-saving conditions, it can enter the automatic energy-saving state. By setting the VF function, one-to-multiple and long-distance control applications can be realized to meet the application of transformation occasions

automatic energy saving

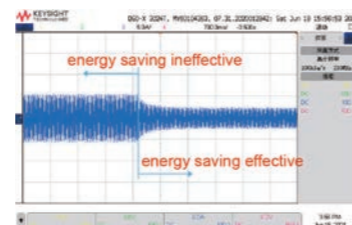

Excellent speed tracking function

Achieve smooth start without impact for the motor which does not stop rotating

Speed tracking current waveform

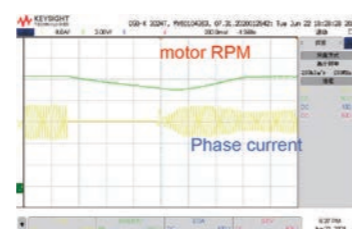

Strong PC tool commission

Strong PC tool commission, equipped with Modbus communication as standard, up ports virtual terminals.

Programmable logic applications and complete protection functions;

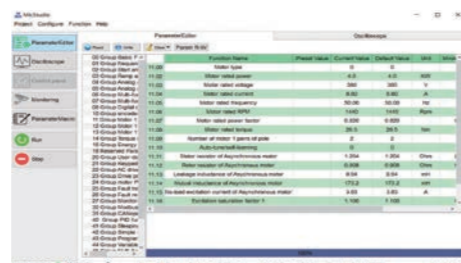

Advanced drive technology

Capable of driving different types of motor. VFD530 series runs not only induction motors, but also synchronous motors like IPM*1 and SPM*2 motors with high performance open and closed loop vector control.

Minimize equipment needed for your business by using the same drive to run induction and synchronous motors

*1 Interior Permanent Magnet Motor (Motors with permanent magnets inserted into the rotor)

*2 Surface Mounted Permanent Magnet Motor (Motors with permanent magnets mounted on the surface of the rotor)



Positioning capability without external devices



Use an IPM motor to perform position control -without motor feedback. Electrical saliency in IPM motors makes it possible to detect speed, direction, and rotor position without the use of external feedback devices.

Positioning functionality without a PLC. Visual programming in Drive Worcs EZ eliminates the need for external controllers by giving the user the power to create customized functions such as position control.

New Auto-tuning features

Auto-tuning features optimize drive parameters for operation with induction motors as well as synchronous motors to achieve the highest performance levels possible.

Optimizing not only the drive and motor performance, but also automatically adjust settings relative to the connected machinery.

New Auto-Tuning methods. VFD530 continuously analyzes changes in motor characteristics during operation for highly precise speed control.

Synchronous Motor	
Rotational Auto-Tuning	Applications requiring high starting torque, high speed, and high accuracy.
Stationary Auto-Tuning	Applications where the motor must remain connected to the load during the tuning process.
Line-to-Line Resistance Auto-Tuning	For tuning after the cable length between the motor and drive has changed, or when motor and drive capacity ratings differ.
Encoder Auto-Tuning	For running the motor at top efficiency all the time

Tuning the Load	
ASR* Tuning	Perfects responsiveness relative to the machine. Until now, this tuning procedure was fairly time consuming to set.
Inertia Tuning	Optimizes the drive's ability to decelerate the load. Useful for applications using Kinetic Energy Buffering Function and Feed Forward functions.

Product Features

Powerful torque characteristics

Powerful torque at 0 Hz, without sensors or feedback devices. Until recently, sensorless control has been out of reach for synchronous motors.

VFD530 series provides powerful starting torque algorithm without relying on pole sensors or motor feedback.

High-performance current vector control achieves powerful starting torque with an induction motor.

Torque characteristics
Advanced Open Loop Vector with an IPM motor

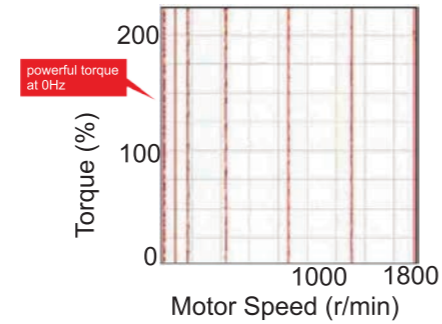

Synchronous Motor	
Advanced Open Loop Vector for PM motors	200% rated torque at 0 r/min*, speed range of 1:100*
Closed Loop Vector Control for PM motors	200% rated torque at 0 r/min, speed range of 1:1500

* only IPM motor

Induction motor	
Open Loop Vector Control	200% rated torque at 0.3 Hz*, speed range of 1:200
Closed Loop Vector Control	200% rated torque at 0 r/min*, speed range of 1:1500

* Proper output torque depends on matching drive and motor capacity.

Even more compact

VEIKONG continues to make applications even smaller by combining the compact designed drive with the light, efficient design of asynchronous motor.

Use Side-by-Side installation for an even more compact setup

Finless models available*

Example:380V 90KW

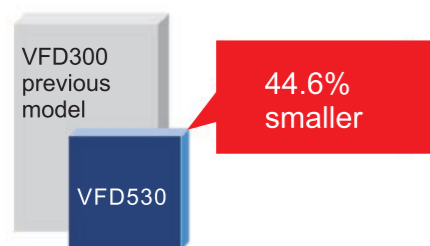

Example shows a 220V 3.7KW motor

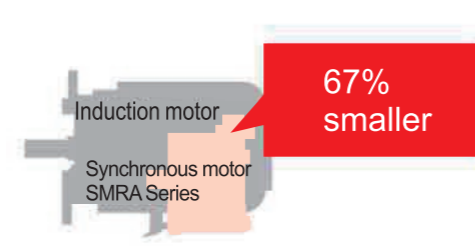

Independent duct design

Independent air duct design, effectively preventing dust entering inverter, causing short-circuit and other faults and improving reliability

Use bigger air volume and long life cooling fan effectively reduces the internal temperature rise of the inverter and ensures reliable and stable operation of inverter.

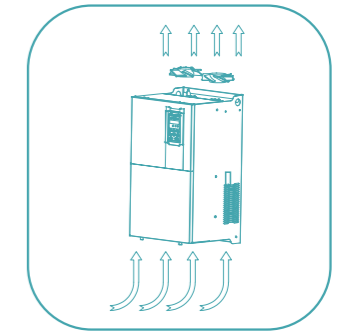

Perfect protection system

Designed for 10 years of maintenance-free operation.

Cooling fan, capacitors, relays, and IGBTs have been carefully selected and designed for a life expectancy up to ten years

*Assumes the drive is running continuously for 24 hours a day at 80% load with an ambient temperature of 40°C



Rigorous temperature rise test

The whole machine temperature rise test uses the most severe cyclic overload test to meet the long-term reliable operation under extreme load conditions

Cyclic overload test: 1.5 times overload current for 1 minute ambient current for 4 minutes, and 1.5 times operation for 1 minute at ambient temperature of 40

This continuous cycle operation, 1 cycle for 5 minutes until the system reaches the thermal equilibrium state the whole machine is within the thermal design safety range

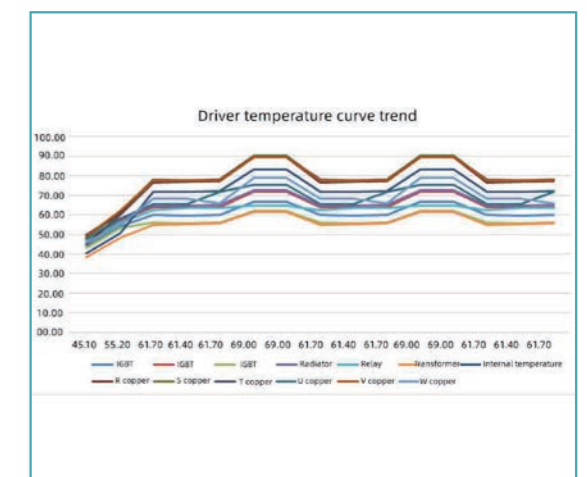

Product Features

Complete protection

The whole series has output to ground short circuit protection, over current protection, drive overload protection motor overload protection, drive over temperature protection, optional PT100/PT1000 motor over temperature protection.

According to the type of fault, it can be set as fault free stop, fault deceleration stop, fault continue to run, and facilitate the on-site handling of emergency situations.

Adopting multiple high-quality three-proof paint to enhance the environmental adaptability of the product, The three-proof paint adopts the automatic spraying process to ensure the uniformity of the thickness of the coating and the consistency of the batch.

Powerful internal logic

Built-in up to 6 sets of delay functions, a wide variety of input sources, the output can be used as a variety of other built-in module inputs.

Built-in up to 4 sets of comparator units, any input, multiple comparison functions, the output can be used as a variety of other built-in module inputs.

Built-in up to 4 sets of logic units, arbitrary inputs, multiple logic operations, and output scan be used as inputs for various other built-in modules.

The above modules can be used alone or in combination to achieve complex internal logic functions to meet various applications, saving peripheral equipment and wiring

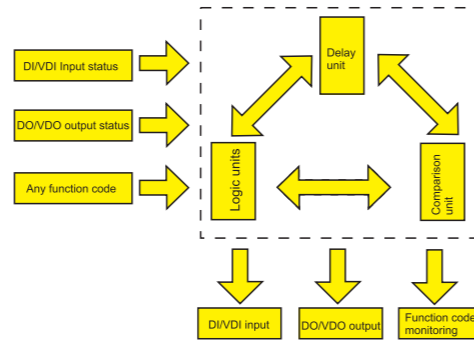

Energy saving function

It has excellent automatic energy saving function, only need to set the maximum energy saving target, as long as the operation meets the energy saving condition, it can enter the automatic skill state.

By setting the VF function, it can realize the application of 1 drag and long distance control to meet the application of the transformation occasion.

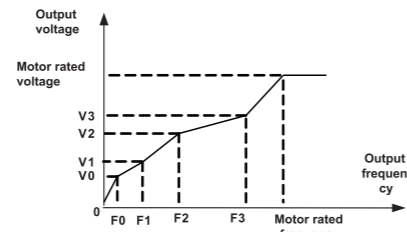
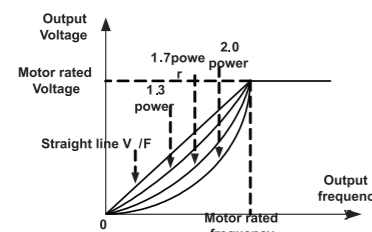
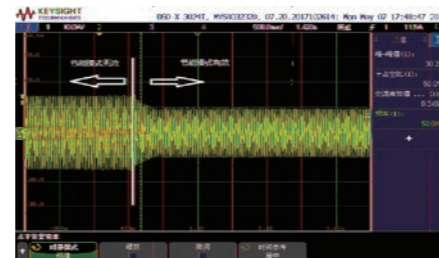

Special IO 2 board design for VFD530 series

IO 2 wiring map

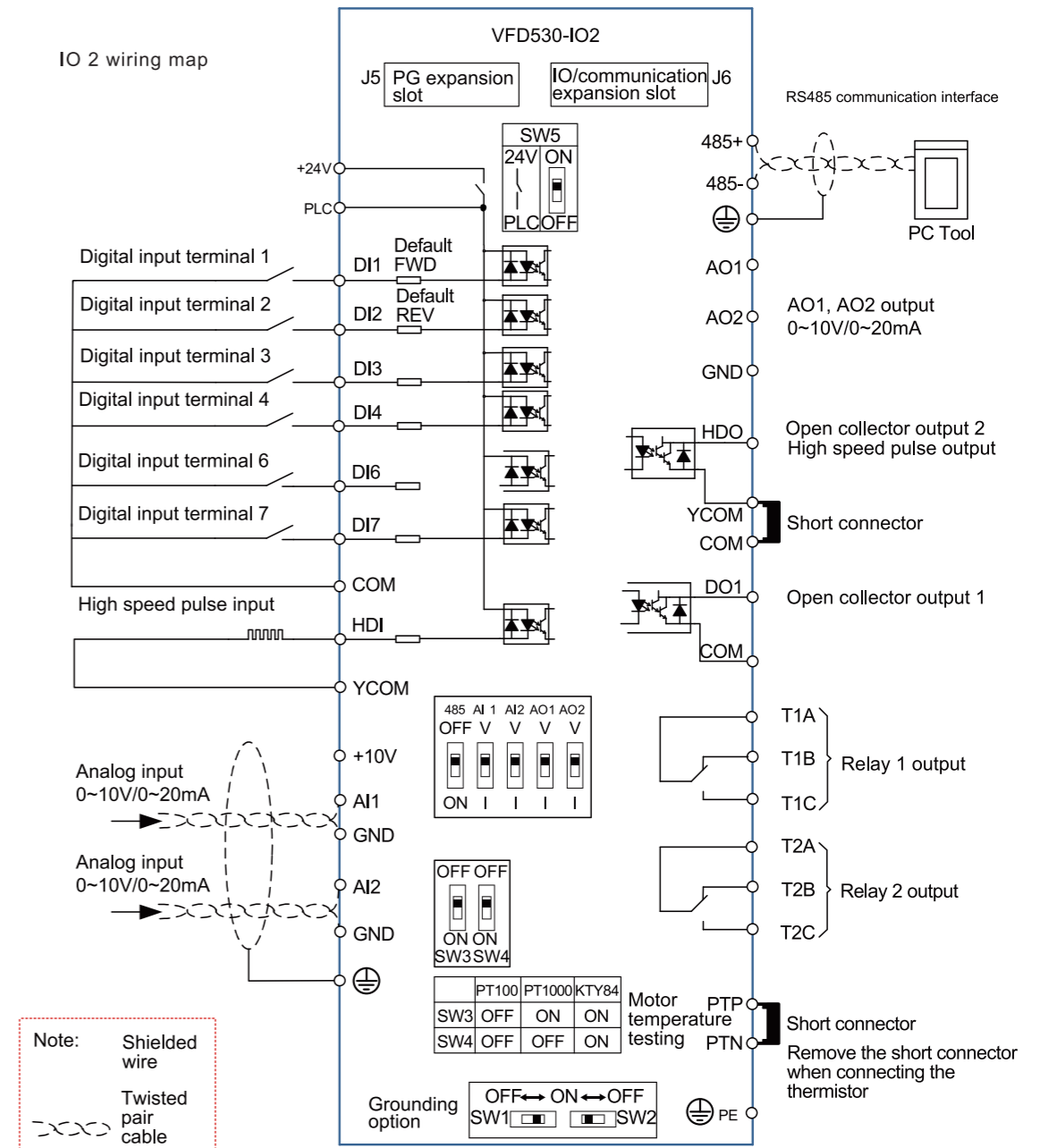

Crane and hoist logic

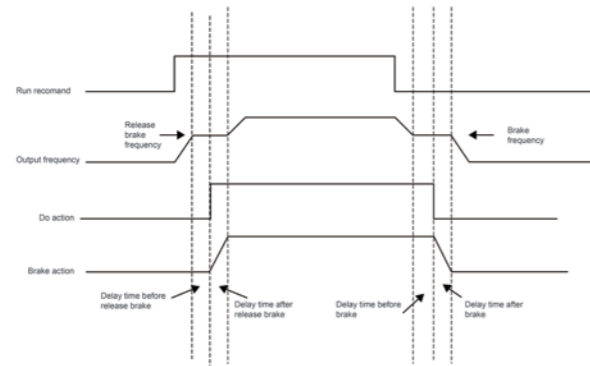

Extension cards for options

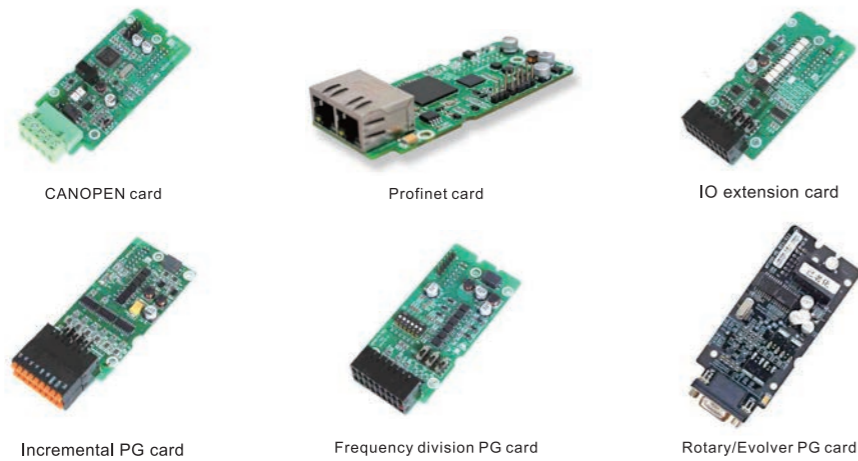

Multiple display for options

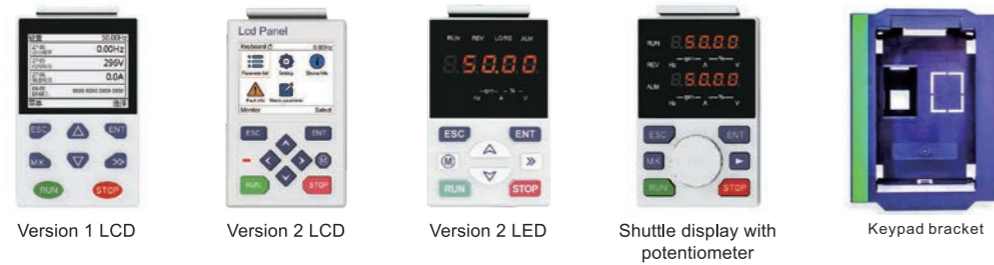

DC reactor and braking chopper for options

18.5-200 KW can be built-in DC reactor for options, 30-75KW can be built-in braking unit for options

Support non-standard software custom development

VEIKONG OEM service has helped more and more clients been unique and special in his own market and grow better step by step. Besides, what makes VEIKONG different from other supplier lays on the high standard technology we can achieve for our clients like the nonstandard software custom development.

VEIKONG, your trusted supplier for higher standard VFD project!

VEIKONG
www.veikong-electric.com
www.veikong.com

Advanced Features

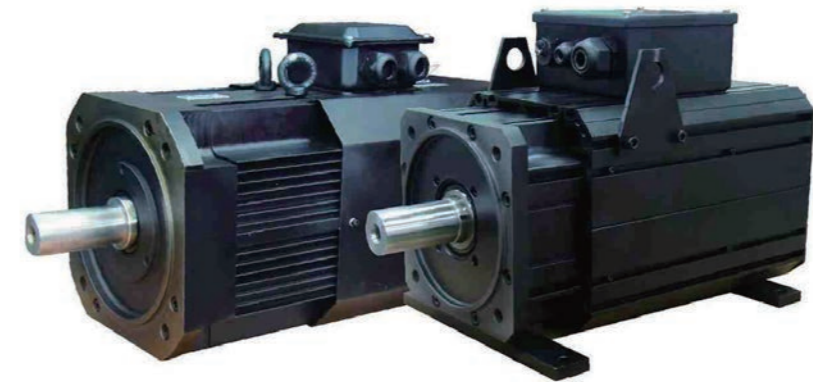

VFD530 High Performance PMSM AC Drives

Advanced Features

STO (Safe Torque Off) function

Compliant with IEC 62061-SIL3. Enhancing safety by immediately shutting off torque output to the connected motor, making it an effective measure for preventing accidents in industrial settings.

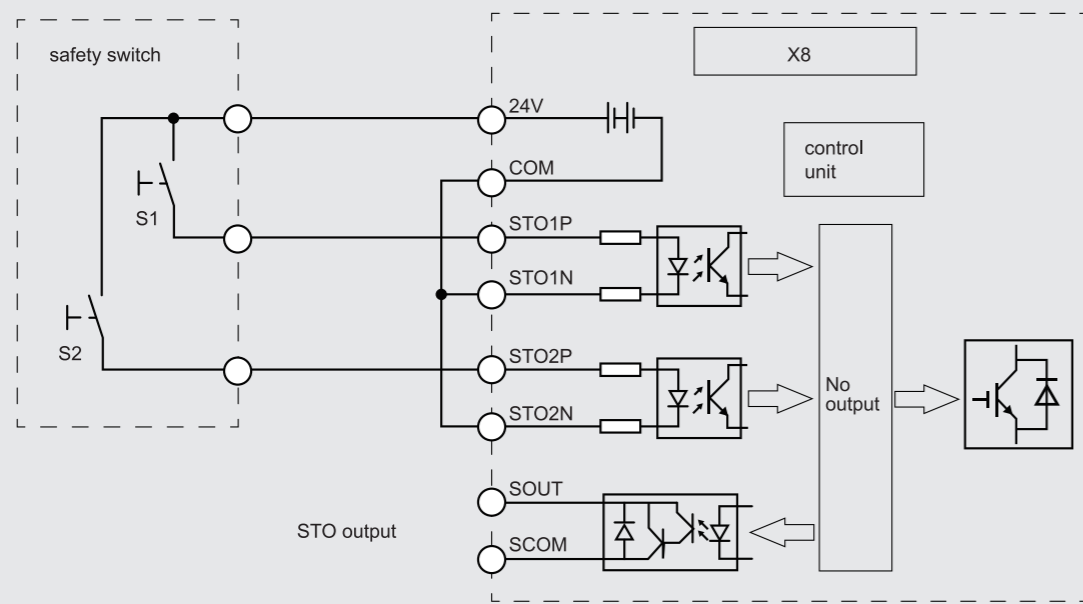

TCP protocol

VEIKONG VFD530 series are updated with TCP protocol which has the following advantages:

1. Reliability: TCP is a reliable protocol, ensuring that all data packets are delivered to the intended recipient.
2. Error-checking: TCP has built-in error-checking mechanisms, ensuring that transmitted data is accurate and error-free.
3. Streamlined communication: TCP minimizes unnecessary network traffic, reducing delays and improving efficiency.
4. Security: TCP provides encryption and authentication mechanisms for secure transmission of sensitive data.
5. Scalability: TCP can be easily scaled for larger networks, making it a cost-effective option in the long run.

Overall, using TCP protocol in VFD ensures efficient, secure, and reliable communication.

Fire mode in urgent situations

This safety feature prevents the VFD from shutting down for self-protection. Instead, the drive will continue the vital fan operation even with a control signal, warning or alarm. Fire mode are critical to ensuring safer evacuation of people from buildings in the event of a fire.

Activating the "Fire Mode" function in VEIKONG drives ensures safe and continuous operation in applications such as parking lot exhaust fans, smoke extraction and essential service functions.

Semi-transverse ventilation system in normal mode

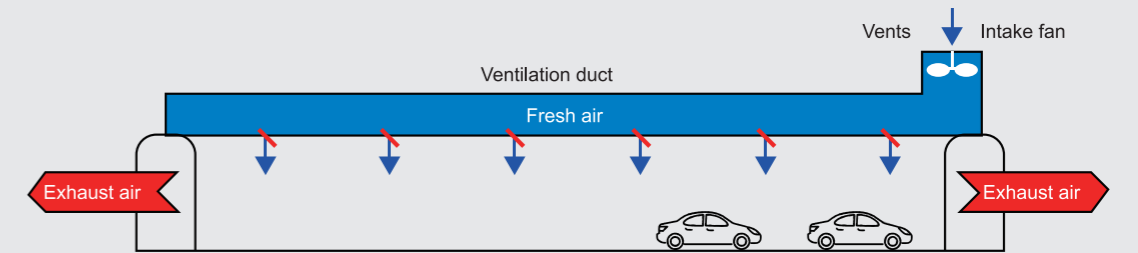

Semi-transverse ventilation systems in case of fire

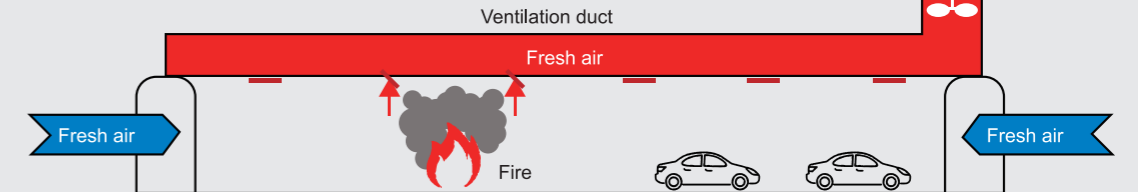

Rich communication card for options

1. Modbus RS485 standard
2. Profinet Canopen optional
3. Profibus is in developing

VEIKONG

www.veikong-electric.com
www.veikong.com

Application Occasions



VFD530 High Performance PMSM AC Drives

VFD530 High Performance PMSM AC Drives

APPLICATION OCCASIONS



Model Instruction



VFD530 High Performance PMSM AC Drives

VFD530 High Performance PMSM AC Drives

APPLICATION OCCASIONS

VFD530 - 4R0G/5R5P - T 4 B

Product series

Model Type and power rating
(G-General Type,P-Fan and pupm Type)

Phase(T-Three Phase,S-Single Phase)

B means
breaking units

Voltage Class
(2-220V,4-380V,6-690V)





Product Series Instruction



VFD530 High Performance PMSM AC Drives

VFD530 High Performance PMSM AC Drives

PRODUCT SERIES INSTRUCTION

Model	Power capacity	Input current	Output current(A)		Adaptable Motor	SIZE	Brake Unit
			Heavy	Light			
Three phase: 380-480V, 50/60Hz							
VFD530-R75GT4B	1.5	3.4	2.5	4.2	0.75kW	SIZE A	Internal
VFD530-1R5GT4B	3	5	4.2	5.6	1.5kW		
VFD530-2R2GT4B	4	5.8	5.6	9.4	2.2 kW		
VFD530-4R0G/5R5PT4B	5.9	10.5	9.4	13.0	3.7 kW	SIZE B	
VFD530-5R5G/7R5PT4B	8.9	14.6	13.0	17.0	5.5 kW		
VFD530-7R5G/011PT4B	11	20.5	17.0	23.0	7.5 kW		
VFD530-011G/015PT4B	17	26.0	25.0	31.0	11 kW	SIZE C	
VFD530-015G/018PT4B	21	35.0	32.0	37.0	15 kW	SIZE D	
VFD530-018G/022PT4B	24	38.5	37.0	45.0	18.5 kW		
VFD530-022G/030PT4B	30	46.5	45.0	57.0	22 kW		
VFD530-030G/037PT4	40	62.0	60.0	75.0	30 kW	SIZE E	
VFD530-037G/045PT4	50	76.0	75.0	87.0	37 kW	SIZE F	option
VFD530-045G/055PT4	60	92.0	90.0	110.0	45 kW		
VFD530-055G/075PT4	75	113.0	110.0	135.0	55 kW		
VFD530-075G/090PT4	104	157.0	152.0	165.0	75 kW	SIZE G	
VFD530-090G/110PT4	112	170.0	176.0	210.0	90 kW	SIZE H	External
VFD530-110G/132PT4	145	220.0	210.0	253.0	110 kW		
VFD530-132G/160PT4	170	258.0	253.0	304.0	132 kW		



PRODUCT SERIES INSTRUCTION

VEIKONG

www.veikong-electric.com
www.veikong.com

Technical Specifications



VFD530 High Performance PMSM AC Drives

Model	Power capacity	Input current	Output current(A)		Adaptable Motor	SIZE	Brake Unit
			Heavy	Light			
Three phase: 380-480V , 50/60Hz							
VFD530-160G/185PT4	210	320.0	304.0	360.0	160 kW	SIZE I	External
VFD530-185G/200PT4	245	372.0	360.0	380.0	185 kW	SIZE J	
VFD530-200G/220PT4	250	380.0	380.0	426.0	200 kW	SIZE K	
VFD530-220G/250PT4	280	425.0	426.0	465.0	220 kW		
VFD530-250G/280PT4	315	479.0	465.0	520.0	250 kW	SIZE L	
VFD530-280G/315PT4	350	532.0	520.0	585.0	280 kW		
VFD530-315G/355PT4	385	585.0	585.0	650.0	315 kW	SIZE M	
VFD530-355G/400PT4	420	638.0	650.0	725.0	355 kW		
VFD530-400G/450PT4	470	714.0	725.0	820.0	400 kW		
VFD530-450G/500PT4	530	810.0	820.0	900.0	450 kW	SIZE N	
VFD530-500G/560PT4	585	900.0	900.0	980.0	500 kW		
VFD530-560G/630PT4	660	969.0	980.0	1080.0	560 kW	SIZE N	
VFD530-630GT4	720	1100.0	1120.0	1260.0	630 kW		
VFD530-710GT4	800	1245.0	1260.0	1380.0	710 kW		
Single phase :220V ,50/60HZ							
VFD530-R40GS2B	1.3	6.0	3.2	5.6	0.4 kW	SIZE A	Inbuilt
VFD530-R75GS2B	2.4	11.0	5.6	8.0	0.75 kW		
VFD530-1R5GS2B	3.5	15.0	8.0	10.6	1.5 kW		
VFD530-2R2GS2B	5.5	25.0	10.6	14.0	2.2 kW		
VFD530-4R0GS2B	7.7	35.0	23.0	23.0	4.0 kW		
VFD530-5R5GS2B	8.9	53.0	25.0	31.0	5.5kW		
VFD530-7R5GS2B	11	67.0	32.0	37.0	7.5kW	SIZE C	
Three phase 220V ,50/60HZ							
VFD530-R40GT2B	4	6.0	3.2	5.6	0.4	SIZE A	Inbuilt
VFD530-R75GT2B	4	11.0	5.6	8.0	0.75		
VFD530-1R5GT2B	3.5	15.0	8.0	10.6	1.5		
VFD530-2R2GT2B	5.5	25.0	10.6	14.0	2.2		
VFD530-4R0GT2B	11	35.0	17.0	23.0	4.0		
VFD530-5R5GT2B	17	53.0	25.0	31.0	5.5		
VFD530-7R5GT2B	21	67.0	32.0	37.0	7.5	SIZE D	
VFD530-011GT2B	30	46.5	45.0	/	11	SIZE E	Optional
VFD530-015GT2	40	62.0	60.0	/	15		
VFD530-018GT2	50	76.0	75.0	/	18.5	SIZE F	
VFD530-022GT2	60	92.0	90.0	/	22		
VFD530-030GT2	75	113.0	110.0	/	30	SIZE G	
VFD530-037GT2	104	157.0	152.0	/	37		
VFD530-045GT2	112	170.0	176.0	/	45	SIZE G	External
VFD530-055GT2	145	220.0	210.0	/	55	SIZE H	
VFD530-075GT2	145	320.0	304.0	/	75	SIZE I	

Product specification

Item		Specification
Input	Input Voltage	1phase/3phase 220V: 200V~240V 3 phase 380V-480V: 380V~480V
	Allowed Voltage fluctuation range	-15%~10%
	Input frequency	50Hz/ 60Hz, fluctuation less than 5%
Output	Output Voltage	3phase: 0~input voltage
	Overload capacity	General purpose application: 60S for 150% of the rated current Light load application: 60S for 120% of the rated current
Control	Control mode	V/f control Sensorless flux vector control without PG card (SVC) Sensor speed flux vector control with PG card (VC)
	Operating mode	Speed control, Torque control (SVC and VC)
	Speed range	1:100(V/f) 1:200(SVC) 1:1000(VC)
	Speed control accuracy	±0.5%(V/f) ±0.2%(SVC) ±0.02%(VC)
	Speed response	5Hz(V/f) 20Hz(SVC) 50Hz(VC)
	frequency range	0.00~600.00Hz(V/f) 0.00~200.00Hz(SVC) 0.00~400.00Hz(VC)
	Input frequency resolution	Digital setting: 0.01 Hz Analog setting: maximum frequency x 0.1%
	Startup torque	150%/0.5Hz(V/f) 180%/0.25Hz 180%/0Hz(VC)
	Torque control accuracy	SVC: within 5Hz10%, above 5Hz5% VC:3.0%
	V/f curve	V / f curve type: straight line, multipoint, power function, V/f separation; Torque boost support: Automatic torque boost (factory setting), manual torque boost
	Frequency giving ramp	Support linear and S curve acceleration and deceleration; 4 groups of acceleration and deceleration time, setting range 0.00s~60000s
	DC bus voltage control	VdcMax Control: Limit the amount of power generated by the motor by adjusting the output frequency to avoid over-voltage trip; VdcMin control: Control the power consumption of the motor by adjusting the output frequency, to avoid jump undervoltage fault
	Carrier frequency	1kHz~12kHz(Varies depending on the type)
	Startup method	Direct start (can be superimposed DC brake); speed tracking start
	Stop method	Deceleration stop (can be superimposed DC braking); free to stop

Item		Specification
Function	Main control function	Jog control, droop control, up to 16-speed operation, dangerous speed avoidance, swing frequency operation, acceleration and deceleration time switching, VF separation, over excitation braking, process PID control, sleep and wake-up function, built-in simple PLC logic, virtual Input and output terminals, built-in delay relay, built-in comparison unit and logic unit, parameter backup and recovery, perfect fault record, fault reset, two groups of motor parameters freely switch, software swap output wiring, terminals UP / DOWN
	Keypad	LED Digital keyboard and LCD keypad(option)
	Communication	Standard: MODBUS communication Option:Profinet and CAN OPEN
Function	PG card	Incremental Encoder Interface Card (Differential Output and Open Collector), Rotary transformer Card
	Input terminal	Standard: 5 digital input terminals, one of which supports high speed pulse input up to 50kHz; 2 analog input terminals, support 0~10V voltage input or 0~20mA current input; Option card: 4 digital input terminals 2 analog input terminals.support-10V- +10V voltage input
	Output terminal	Standard: 1 digital output terminal; 1 high-speed pulse output terminal (open collector type), support 0~50kHz square wave signal output; 1 relay output terminal 2 analog output terminals, support 0~20mA current output or 0~10V voltage output; Option card: 4 digital output terminals
Protection	Refer to Chapter 6 "Troubleshooting and Countermeasures" for the protection function	
Environment	Installation location	Indoor, no direct sunlight, dust, corrosive gas, combustible gas, oil smoke, vapor, drip or salt.
	Altitude	Lower than 1000 m
	Ambient temperature	-10°C~+40°C (derated if the ambient temperature is between 40°C and 50°C)
	Humidity	Less than 95%RH, without condensing
	Vibration	Less than 5.9 m/s ² (0.6 g)
	Storage temperature	-20°C ~ +60°C
Others	Installation	Wall-mounted, floor-controlled cabinet, transmural
	Protection level	IP20
	Cooling method	Forced air cooling



After sale service system

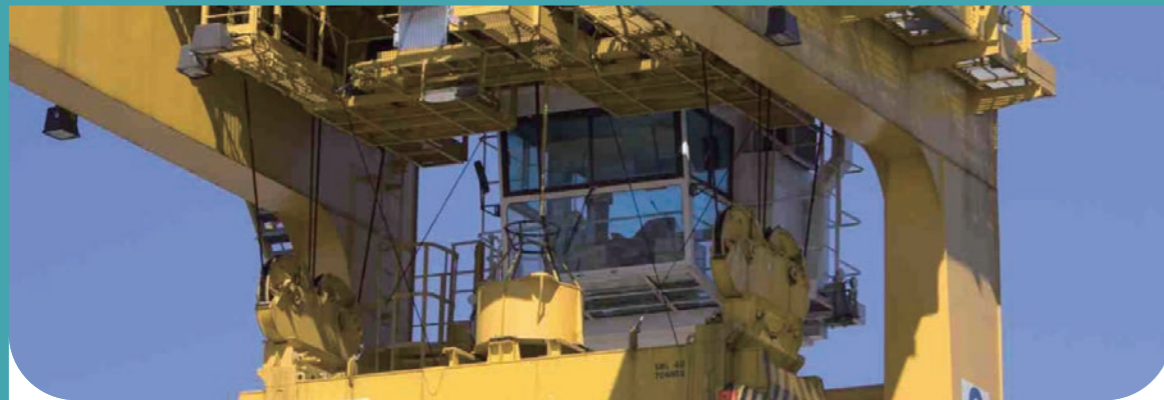

VFD530 High Performance PMSM AC Drives

VFD530 High Performance PMSM AC Drives

AFTER SALE SERVICE SYSTEM

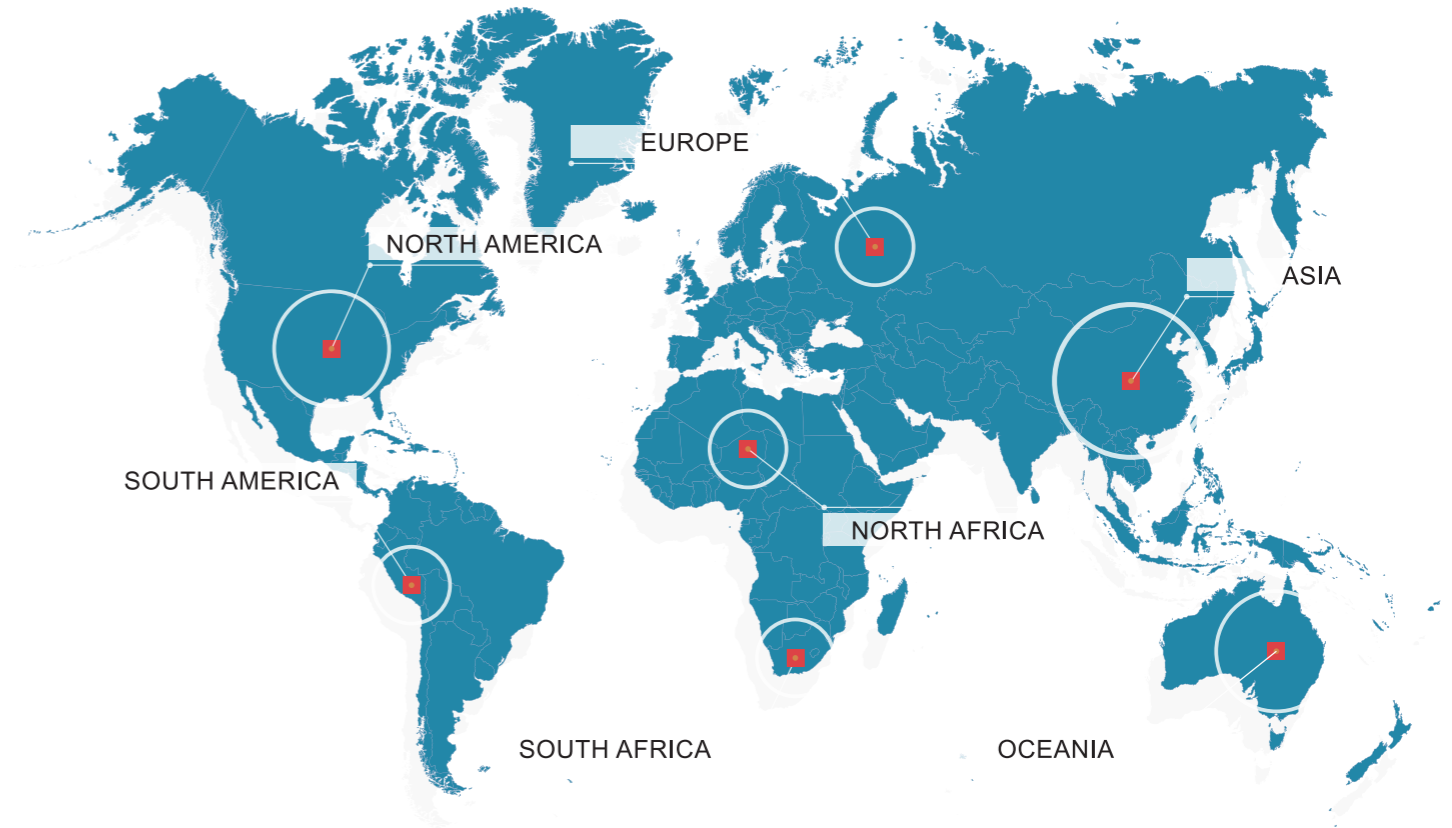

1. VEIKONG offers you 18-month quality guarantee. We will take responsibility for any problems caused during this period. As long as customers provide us with VFD error reports, we will provide free repair parts for them.
2. Please contact your sales representative in a timely manner, if you have any problems during usage. Meanwhile, we will build a professional technical team online to solve complex application issues for you.

VEIKONG, your trusted supplier!